

Uddannelse til fremtidens produktion

Krav til os i industrien

- Relevant
- Konkurrence dygtig
- Bæredygtig

Behov for uddannelse

- Komplexiteten er for høj til at ledere og projektledere kan koordinere

Christian Rasmussen

Senior Manager, Data Analytics

Grundfos

The future digital ecosystem

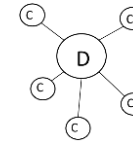

D = Driver

C = Contributor

• = API

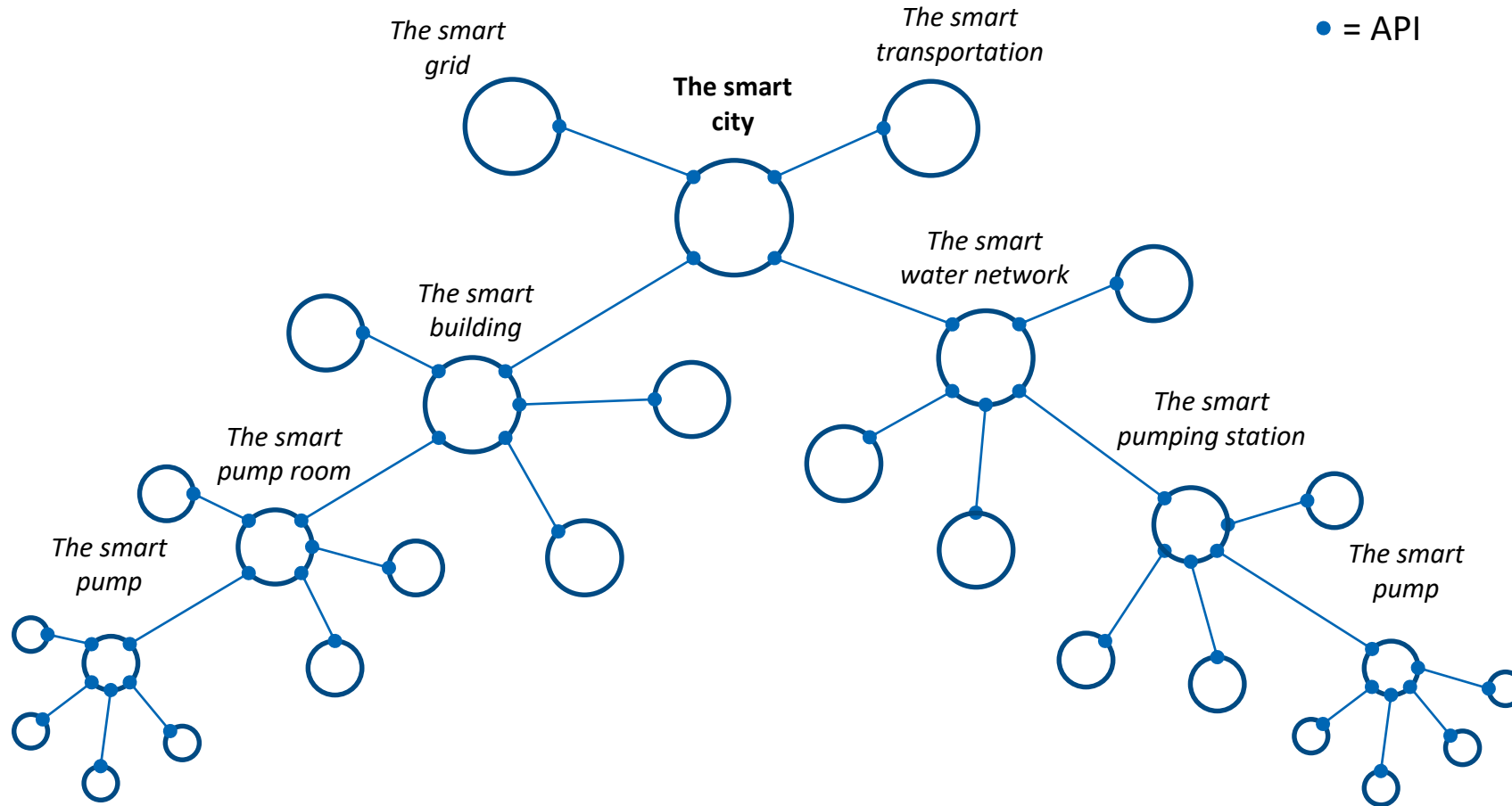

2018-03-28 14:46:42

阿里智慧园区数据大屏

实时车流量



已用车位 2,498个 剩余车位 237个

能耗管理

水

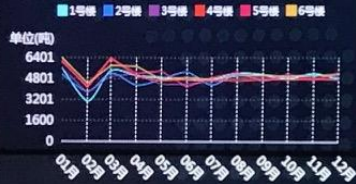

电

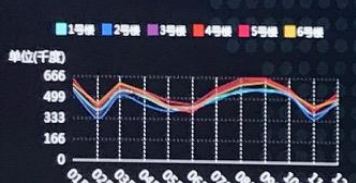

设备监控数据

设备名称	总数	使用数量	故障数量
智慧路灯	58	56	2
视频监控	287	283	4
门禁系统	1257	1235	22
消防系统	581	581	0

园区环境

室外 室内



园区运营管理数据

空闲场地数量 1.42万方

园区入住率 93.0%

信用生活

设备名称	总数	使用	剩余	故障
共享充电宝	36	36	0	0
共享停车位	200	179	21	0
共享单车	100	36	56	8
共享雨伞	50	50	0	0

无人零售柜

总数	当日零售次数	1538次
正常	29	当日零售金额 24361元
异常	1	当月零售金额 54384元

共享打印机

总数	当日打印量	5714次
正常	194	当月打印量 16万次
异常	6	

企业数据可视化



小邮局

当日收发量	1,644封
当月收发量	51,857封
因公数量	43,582封
因私数量	8,1275封

趋势



企业数据可视化

当日访客量 879人 累计访客量 579,032人

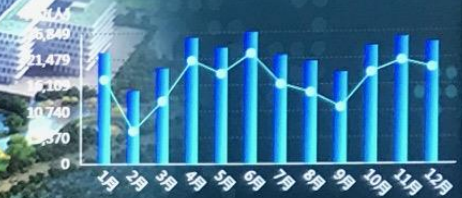

员工入园比例

员工总数 16,932人



阿里园区总面积26万平方米

共享会议室(剩余)

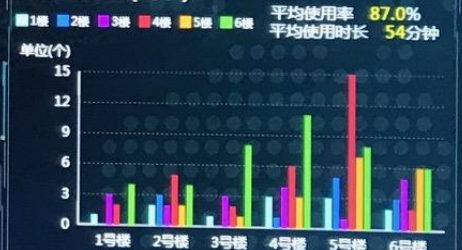

共享工位(剩余)



Data Supply Chain

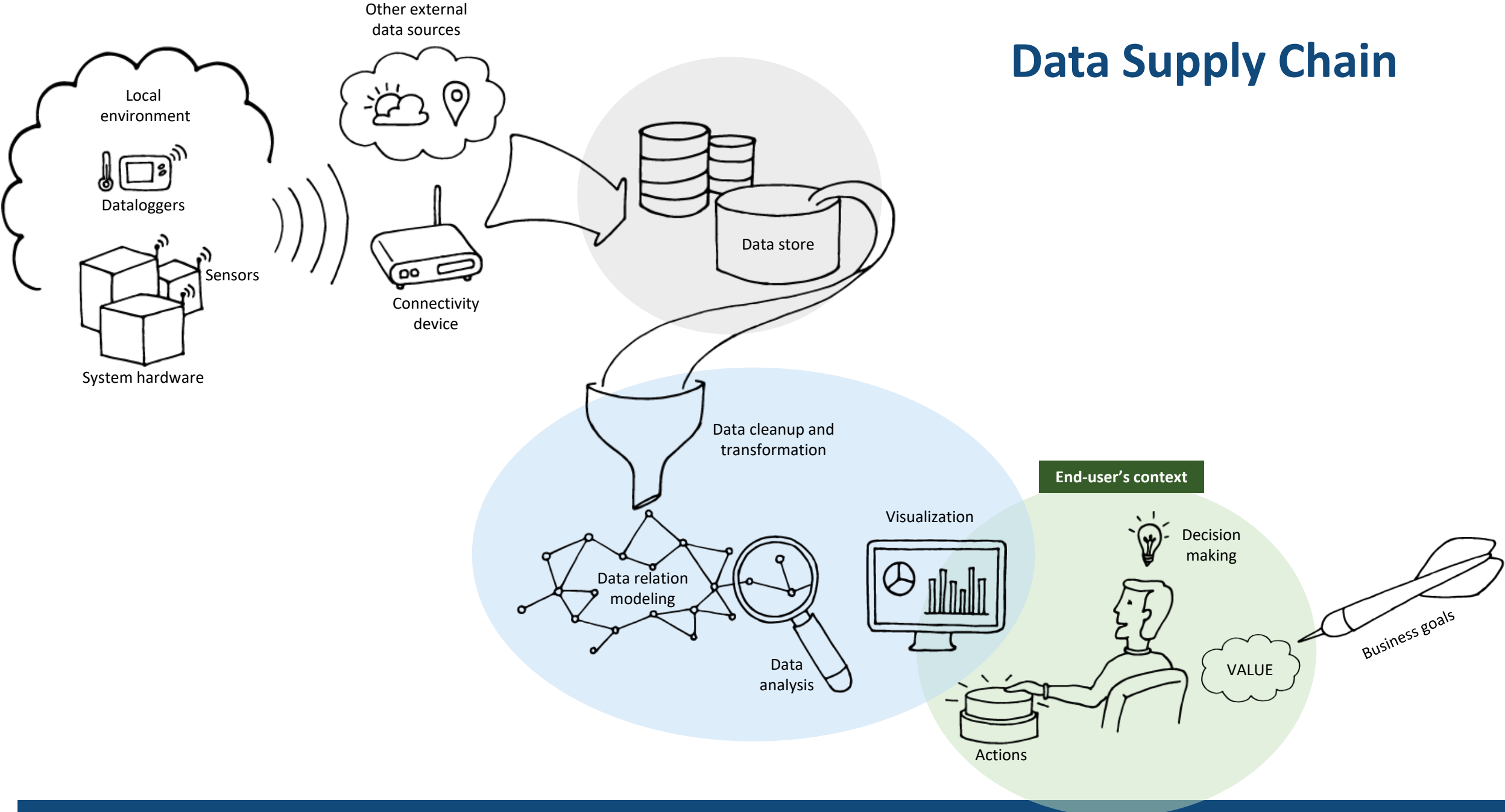

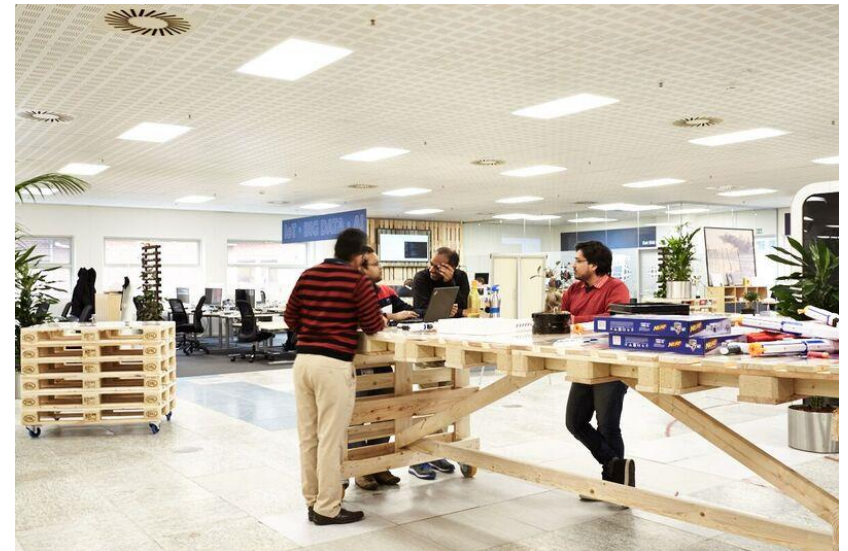
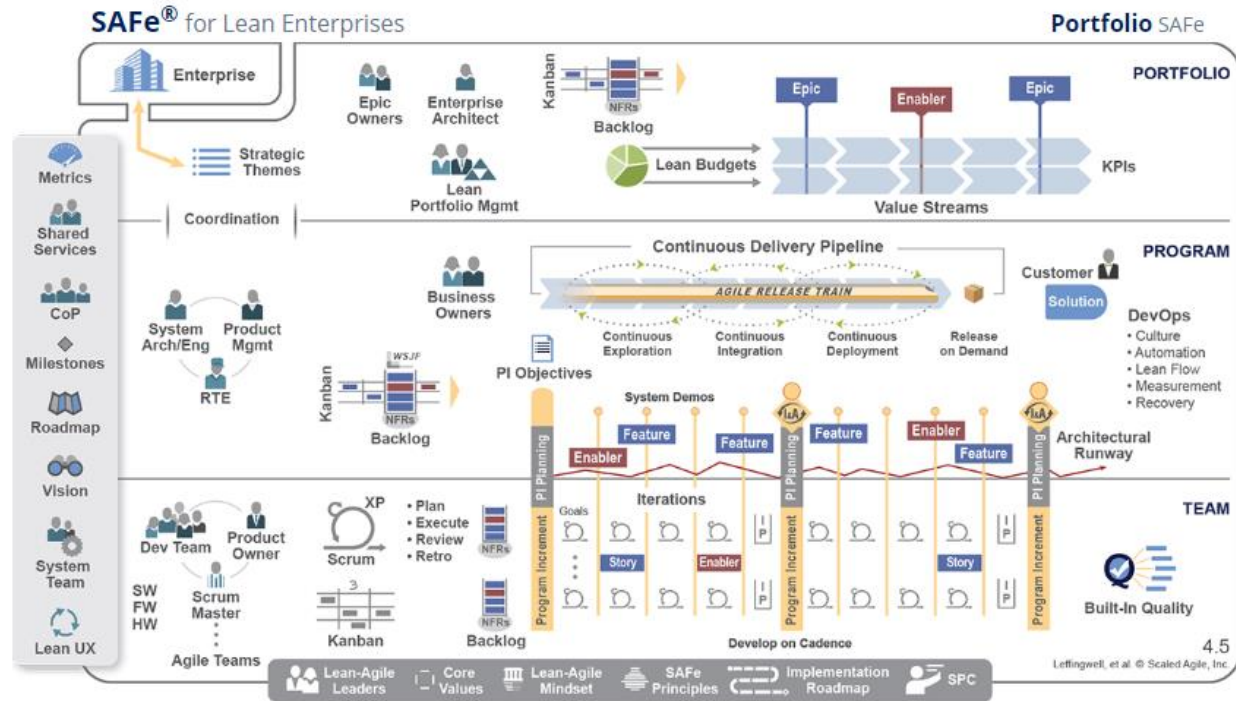



- **Ingeniører, der er ude på gulvet – der taler med montører og hører om, hvad der sker på gulvet. De skal kunne begå sig på alle niveauer. Før alt andet – det er danskere gode til – kultur.**
- **Ingeniører og operatører skal tage ansvar, ikke være for forsigtige. Tage ejerskab på problemer og få det løst og finde løsninger. Se realiteterne i øjnene.**

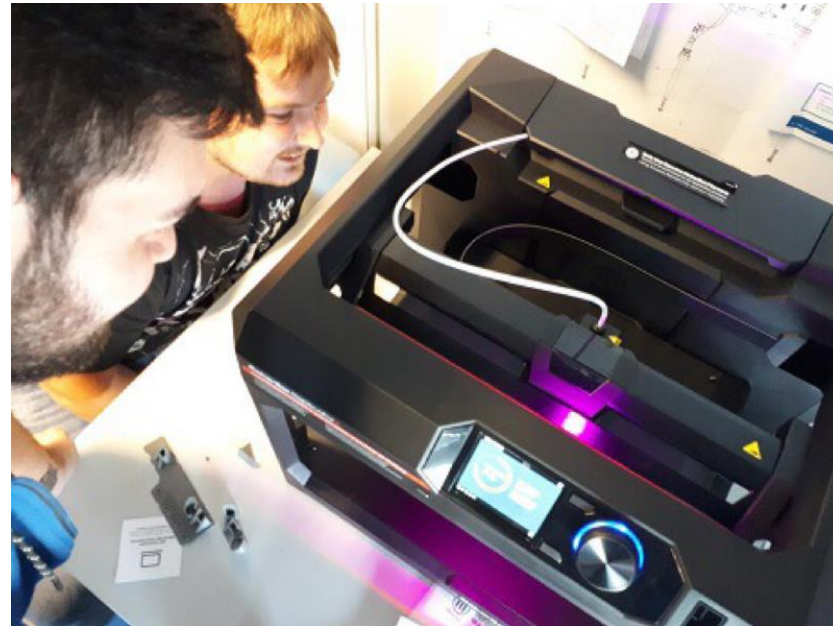
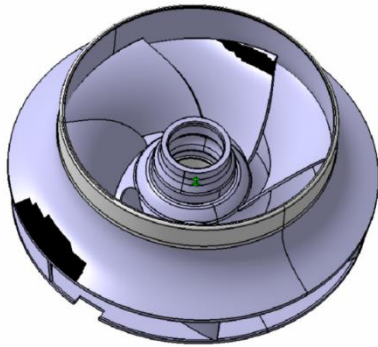

Bæredygtig



HOW WE ROLL | #wol



Big Data & AI Lab

We can and must use data better to create new value

NEW CONVERSATIONS ALL CONVERSATIONS FILES SEARCH

Joined

Update Poll Praise Announcement

Share something with this group...



Kasper K. Christensen – Monday at 8:18am – Edited

#dawol

cc: Christian Rasmussen, Narenth Veluppillai, Poul Ejlersen, Signe Horn Thomsen, Rasmus Kjær Ursem, José Luiz Ferreira, and Simon Eberle

LIKE REPLY SHARE

Thomas Asger Hansen and Alin Ene like this

Seen by 222

#Daywol #Wwnc #Datascience #Welcome
#2018w12 #Bigdatawol #WOL #Azurefunctions #Leakdetection
#Deeplearning #Dawol

MEMBERS (344)



INFO

Edit

- Follow the weekly big data horizon watch to learn what is going on: [#bigdatawol](#)
- For documents, planner, etc, join the Big Data and IoT Lab on Microsoft Teams

GROUP ACTIONS

View Group Insights

Big Data & AI Lab

NEW CONVERSATIONS ALL CONVERSATIONS FILES SEARCH



UNLIKE REPLY SHARE

You, Mikkel Haggren Brynildsen, Kim Hyldgaard, and Kasper K. Christensen like this



Christian Rasmussen – 5 hours ago

#dawol #wol

This week I will talk at the Data Innovation Summit in Stockholm together with Thomas Asger Hansen. We will start from the SDG6 cover how AR supported service of BioBoosters can keep more BioBoosters up and running.

The center piece is how we seek to reduce complexity of a digital transformation in a company with 8 main product lines x 4 business segments x 20 applications through the way we work and collaborate. We reduce complexity by making customer need pilot projects end to

Kompleksiteten er for høj til at ledere og projektledere kan koordinere

- STEM med faglig dybde
- Evnen til at bringe egen og andres fagligheder i spil i de tværorganisatoriske teams



Christian Rasmussen
Senior Manager, Data Analytics
Grundfos

be
think
innovate

GRUNDFOS 